

Notes:

104 mm tweeter speaker,
Textile dome,
terminals: 2.8 x 0.5&5.2*0.5 mm,
magnet: Ø 70 x 15mm,

Frequency response:2.83V/1m

Nominal impedance(ohm):	8
Voice coil resistance(ohm):	5.5
Nominal power(W):	50
Sensitivity 1w/1m (dB):	89
Frequency range(kHz):	1.0-30
Free air resonance(Hz):	1000
Voice coil diameter(mm) :	25
Voice coil height(mm) :	1.6
Air gap height(mm) :	3
Voice coil inductance(mH):	—
Eff.diaphragm Area(cm ²):	—
Moving mass(g):	—
Magnet weight(g)/(oz):	228/8
Force factor(BI):	—
VAS(l):	—
Qms:	—
Qes:	—
Qts:	—

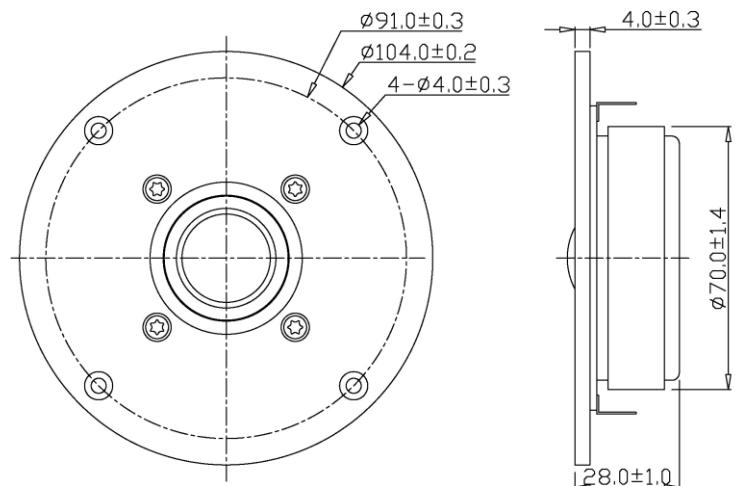

TECHNICAL DATA ARE MEASURED WITH LMS – EQUIPMENT ACCORDING EN – 60268 –5.

FOR PRODUCT IMPROVEMENT FDCAUDIO RESERVES ALTERATIONS IN SPECIFICATIONS AND DESIGN WITHOUT FURTHER ANNOUNCEMENT FOR TOLERANCES OF TECHNICAL DATA REFER TO FDCAUDIO 'S MANUAL OF TECHNICAL DATA

FOR INFORMATION CONTACT: TEL.:+86-592-2076023,FAX.:+86-592-2033445,E-MAIL:mengqi@fdcaudio.com